

Trenchless pipe laying

directional



Comprehensive pipe systems





## Contents:

Introduction	03
01 horizontal directional drilling	
phase 1 : drilling the pilot hole	04
phase 2 : enlarging the pilot hole	06
phase 3 : pulling the pipe string	08
02 pipe bursting	10
03 pulling through a casing	12
04 the benefits of trenchless pipe laying	16
05 the PAM offer	18
06 anchoring technologies	20
07 the material	22
08 the PAM service	24
09 the PAM experience	26
10 the PAM range	28



# Trenchless pipe laying



Ductile iron represents a reliable and advantageous alternative to the materials normally used in horizontal directional drilling. The sturdiness, modularity and durability of cast iron pipes is combined with proven technology to enable pipeline flexibility.

## A little history

The horizontal directional drilling technique appeared at the beginning of the 20<sup>th</sup> century but only started to interest the oil industry at the end of the 1920s. A large number of improvements, in particular to the guidance system and the drilling equipment was needed before it was possible to progress in the 1930s from drilling "at an angle" to true directional drilling that could follow a curved path.

The further improvement in the 1970s in hydraulics have enabled uninterrupted drilling and the pulling through of rods to a predetermined profile. With the development of location tools, horizontal directional drilling has truly become an effective technique.

## 3 types of implementation

The development of ductile iron pipeline anchoring techniques has enabled PAM to offer complete solutions for trenchless pipe laying.

Based on the mechanical strength and the angular deflection capability of Universal Ve self-anchored joints, PAM has chosen 3 trenchless pipe laying techniques:

**horizontal directional drilling, pipe bursting and pulling into a sleeve.**

*« There are places where being unobtrusive is paramount. »*



# 01

## Horizontal directional drilling Phase 1



### Drilling the pilot hole

A drilling machine located at the pipe's exit point will carry out the pilot drill to the pipe string start point. An electronic sonde, located in the drilling head and coupled with a detection and guidance system will enable the planned path to be followed with great accuracy (+/- 5 centimeters).

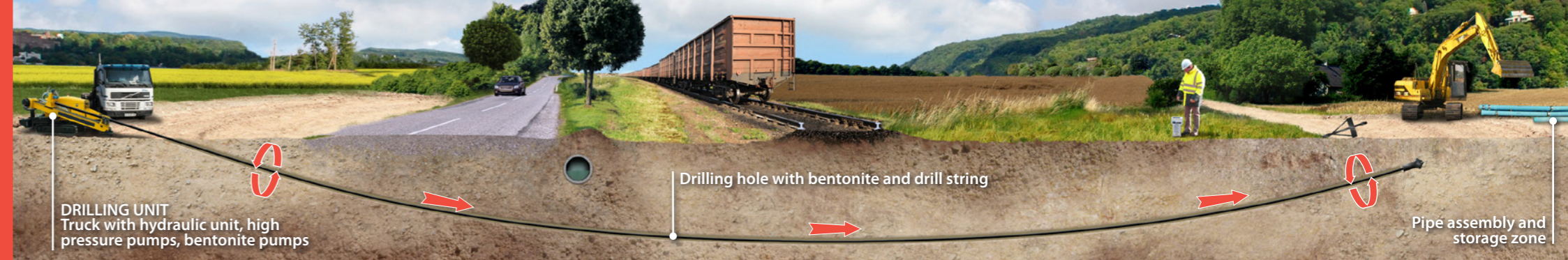

Horizontal directional drilling enables a pipeline to pass under an obstacle, such as a canal, a river or a road. Unlike horizontal boring technique that require major excavation at both ends, the curved trajectory of horizontal directional drilling enables the pipeline to pass under obstacles starting from ground level.

- Horizontal directional drilling performance depends on several factors:
- nature of the ground
  - stratigraphy
  - drilling radius
  - profile regularity
  - nature of the pipeline
  - installation footprint...

#### Each situation has its own solution!

Only certain soils remain unsuitable for the horizontal directional drilling technique (mainly liquefied clay and gravel) as the drilling heads are selected for conditions from soft ground to very hard rock such as granite or even basalt.

### Drilling with 3 tools

The **drilling head**, fitted with a cutting head suited to the ground, injection nozzles and a **sonde**, is driven by a string of hollow steel tubes: the **drilling rods**.

- The drilling rods are used to:
- push the drilling head
  - rotate the drilling head and its tools
  - direct curved drilling in a vertical and/or horizontal direction
  - transport the drilling fluid
  - pull the boring tools
  - install the final pipeline

The transmitting sonde located in the drilling head continuously reports its altimetric and planimetric position. This enables the operator to guide the drilling accurately using the information they see on their screens.

Since the drilling head is asymmetric or fitted with independent rollers, its trajectory can be modified during continuing drilling.

There are different drilling tools suitable for the constraints presented by the ground encountered (boring head, enlarging cone, diamond tip, etc.).



### Pipe laying by HDD\* to DN 1000

Simple and easy to use and supplied as 6 or 7 meters pipes, PAM pipes feature a TT (all-terrain) external barrier coating, suited to installation using horizontal directional drilling.

(\* Horizontal directional drilling)



# 01

## Horizontal directional drilling Phase 2



### Enlarging the pilot hole

When the drilling head exits at the opposite end, it is replaced by a boring head that will be pulled in the opposite direction by the drilling unit. Traversing the pilot hole along the entire path, the boring head widens the hole diameter, adapting it to the dimensions required for the pipeline to pass through.



### Recommendations:

It is common practice to select the final bore diameter using the following data.

Length or type of drilling	Final boring diameter
less than 50 metres	$D \text{ --- } \bigcirc \text{ --- } 1.2 \times D$
from 50 to 100 metres	$D \text{ --- } \bigcirc \text{ --- } 1.3 \times D$
from 100 to 300 metres	$D \text{ --- } \bigcirc \text{ --- } 1.4 \times D$
more than 300 metres	$D \text{ --- } \bigcirc \text{ --- } 1.5 \times D$
drilling through rock	$D \text{ --- } \bigcirc \text{ --- } 1.5 \times D$

**D** = pipe socket outside diameter

The bore diameter varies according to the diameter of the pipeline to be installed as well as the drilling length, the nature of the ground, the curve radius, etc. It may be necessary to carry out successive boring operations, using boring tools of increasing diameter, to obtain the correct diameter which is between 1.2 and 1.5 times the pipeline diameter.

The boring head is fitted with injection holes, like the drilling head. Injecting bentonite reduces the effects of heating and friction.

### Did you know

Bentonite is a fine clay mixed with water to form drilling mud. This mud enables the drilling and boring tool to be cooled, consolidates the tunnel wall and even assists drilling due to pressure. It also contributes to the removal of spoil before the pipeline is pulled through. It is possible to slightly adjust the density of this product, sometimes during operation, to facilitate drilling and pulling. Drilling mud is generally recycled and used in a closed loop.



### Where innovation combines with savings

Horizontal directional drilling techniques are innovative in the field of saving energy, saving materials and recycling. Beyond the virtuous circle illustrated by bentonite treatment and reuse, horizontal directional drilling enables a 4X reduction in greenhouse gas emissions compared to a traditional operation. (e.g. emission of 30 kg CO<sub>2</sub>e/linear metre of DN 150 pipeline when laid using horizontal directional drilling compared to 119 kg CO<sub>2</sub>e/linear meter when laid using an open trench).



# 01

## Horizontal directional drilling Phase 3

directional

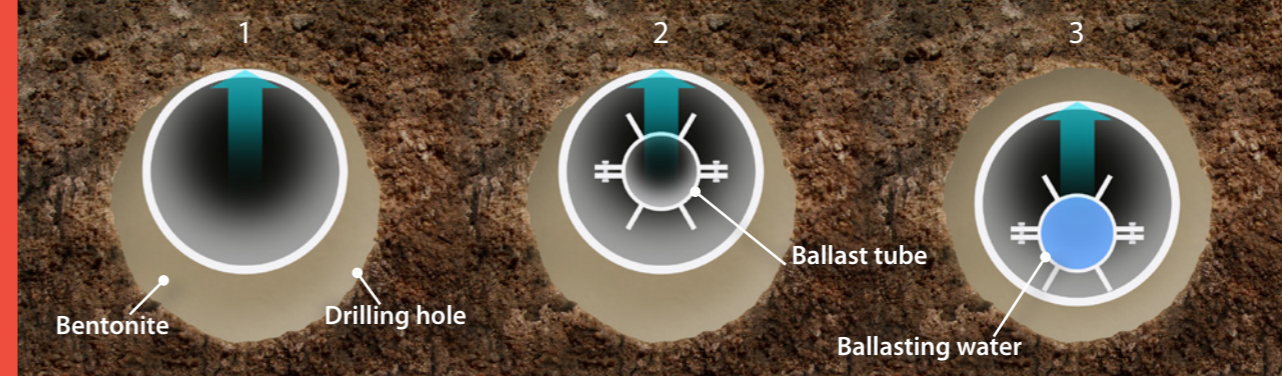

### Ballasting steps



### PAM has designed and produced pulling heads to DN 1000

Once the boring operation is complete, the tunnel remains filled with bentonite. This acts as an excellent lubricant and facilitates the pulling of pipes by reducing friction and force on the joints.



To reduce the pulling resistance of the assembled pipe string upstream, it may be necessary to install a guidance system fitted with support rollers. Furthermore, for pipelines with a diameter greater than 300mm, the hydrostatic thrust applied by the bentonite requires ballasting through the addition of a temporary flexible conduit within the main pipe.

Ballasting involves introducing a temporary ballast in the main pipe using a secondary conduit in order to centre it in the bentonite filled drilling hole to avoid snagging and friction on the upper part of the vault. Depending on circumstances, either the small internal conduit or the circular space between the two pipes will be filled with water.

### Did you know Modularity

The pipes can be pre-assembled as a full length string, pre-mounted in 3-pipe sections, or assembled pipe-by-pipe where site restrictions require. This modularity enables upstream constraints associated with the footprint of the project to be addressed. Ductile iron pipes can be laid in sections – a major benefit in this case.



### Pulling an anchored pipe string

Universal Standard Ve pipes resist very high pulling forces. That makes them the optimum solution for pipe laying using horizontal directional drilling.

### Archimedes knew it a long time ago!

Any body plunged into a liquid at rest, completely immersed in it or passing through its free surface, experiences a vertical force, directed upwards and opposed to the weight of the displaced fluid. Without ballasting, cast iron pipes above DN 300 are pressed against the vault of the drilled bore by the hydrostatic thrust.



# 02 Pipe bursting

direxional



This technique to replace old pipelines enables a damaged pipe to be replaced by a new pre-assembled Universal Ve type ductile iron pipes of an equivalent or slightly greater diameter, depending on the nature of the old pipeline. This technology is also used to considerably reduce the site impact. The pipes are

assembled one by one in a launch pit. The exit pit must be able to contain the extraction machine. A hydraulic device pushes a drill string through the old conduit and on its return, with a bursting head attached, bursts the old pipe with the fragments remaining in situ, while at the same time pulling in the new pipeline.

## Pipe bursting example

At Chambon Feugerolles, near Saint-Étienne in France, this technique was used for an 80 linear metre section between 2 excavated pits to avoid damaging a paved courtyard in front of the town hall and interrupting the town's summer events.



This replacement procedure can only be used for straight sections. An initial diagnosis is required, in particular by carrying out a video inspection of the pipeline to be replaced to ensure that there are no obstacles to impair its extraction or destruction. Where branches exist, these must first be separated from the main pipe and a temporary supply must be provided to ensure water distribution so that service is not interrupted.



## One technique, two processes

Pipe bursting is used to replace one damaged pipeline with another of the same diameter or, often, a slightly larger diameter. The old pipeline can be burst in-situ or removed piece by piece and broken up as it is pushed out of the tunnel.

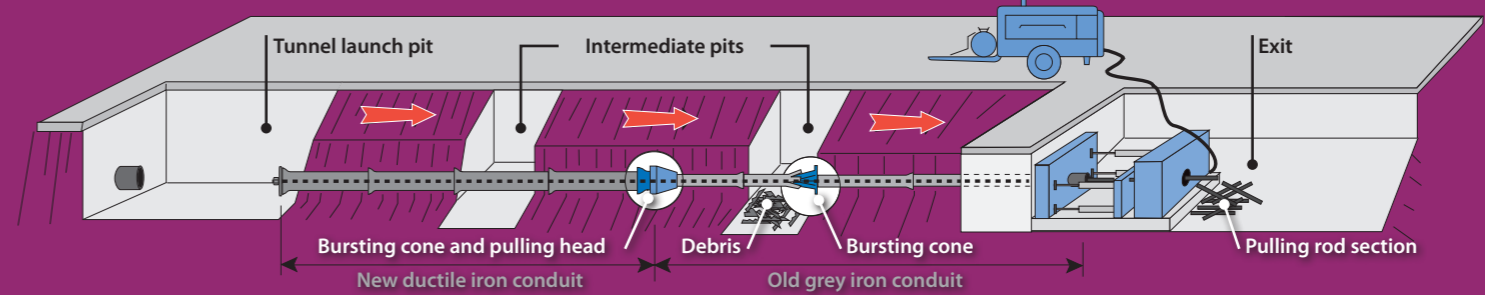

## Pipe bursting replacement



## Pulling through a casing



This laying method can be chosen for specific rehabilitation techniques (passing through an existing damaged pipe) or when laying new networks crossing a natural obstacle or in the case of trenchless works.

When pulling through a casing, you must first define:

- the centring and guiding of each element within the casing
- the method used to anchor the elements together to guarantee the integrity of the section being installed
- the method used to connect the section passing through the casing to the existing network
- the best pulling mechanism from a technical and economic perspective

The choice of pipeline diameter will be guided either by determining the most suitable hydraulic diameter in the case of a new pipeline, or the

inside diameter of the existing pipeline or casing. In parallel, you must ensure that the annular space between the pipe and the casing is sufficiently large to enable the fitting of centring collars that meet the requirements for the guidance and pulling of the conduit within the casing. The nominal diameter chosen, along with the network operating pressure and the pulling force required will enable you to choose the most suitable range of pipes and anchoring method in the PAM range from DN 60 to DN 1200.

To begin with, an access pit or a pipe assembly area will be created where the pulling head anchoring and pipe connection operations can take place. Each pipe is then fitted with centring collars. Their number is first determined according to their material (plastic or metal) and their support capacity. The pipes are then positioned on a wooden or concrete guide along the casing axis.

The pulling device is installed on the first pipe that is then pulled into the casing, with the rear of the pipe overhanging slightly. Different types of pulling mechanisms can then be used depending on the type of pipes installed as well as the length of the string to be pulled. The second pipe is located on the guide and anchored to the first before in turn being pulled into the casing. The process of assembling and pulling the pipes continues until the required length is in place. After pulling the last pipe, the pulling device is removed and tests carried out before connecting the new pipe at both ends.

**Important: the pipes must always be installed by pulling, never by pushing.**

### Pulling through a casing

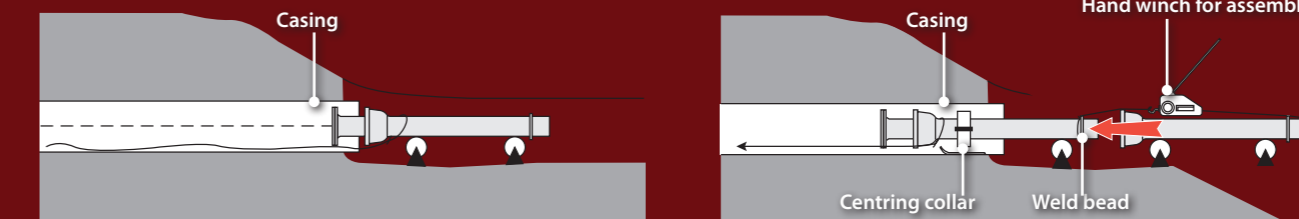

### Did you know ?

For pipes with a nominal diameter greater than 800mm or where there are specific difficulties, it is necessary to use special centring and guiding supports. Depending on the project specifics, PAM will investigate the creation of specific supports and arrange for subcontracting of their supply. With all these types of equipment, it is even possible to insert 2 pipelines within a single casing.

Pipe laying through a casing consists of introducing a pipeline intended to transport a fluid (drinking water, waste water, rain water, dry systems, etc.) within a circular sleeve that already exists or is installed specifically for this application. Ductile iron pipelines are perfectly suited to this application, since the anchored joints can withstand significant pulling forces, while retaining the flexibility offered by elastomer gaskets.



# 04

## The benefits of trenchless pipe laying



### Lower social costs

- no interference with traffic
- no interruption to services
- less damage to the environment
- little or no risk of accidents
- little or no risk of economic consequences for local businesses
- less noise and air pollution for residents

### Lower indirect costs

- fewer road signs needed
- less site security required
- no diversion costs for distributors
- no need to move street furniture

**Savings compared to a traditional site.**

### Lower direct costs

- more technical materials
- no back-filling or compacting, no need to repair roads and pavements, etc.
- lower equipment and lorry costs
- specialist workforce
- fewer personnel
- reduced project time

**Significant savings compared to a traditional site.**

**An ideal solution for a site in a protected environment or an area with a high urban density**



### An economical, durable and unobtrusive solution

Ductile iron has progressively taken its place in the field of horizontal directional drilling thanks to its economic, technical and environmental benefits.



**Bonus: trenchless pipe laying significantly reduces greenhouse gas emissions.**



# direxional





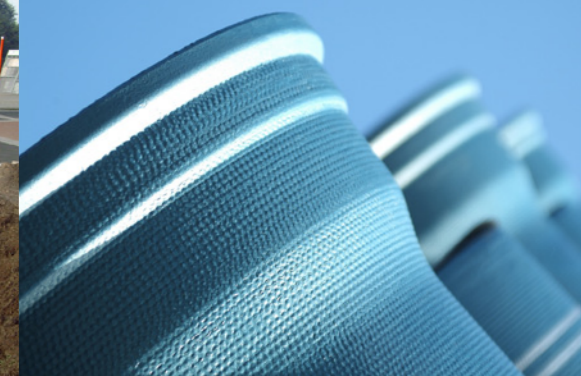

### A la carte solutions

With coatings adapted to the ground conditions and the purpose your pipelines will serve (sewage, distribution and transfer of drinking water), PAM offers its range of Universal Ve pipes coated with:

- Thick polyethylene until DN700

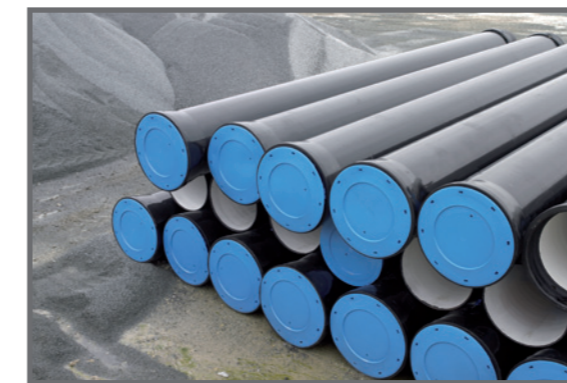

- Reinforced polyurethane for DN800 to 1000

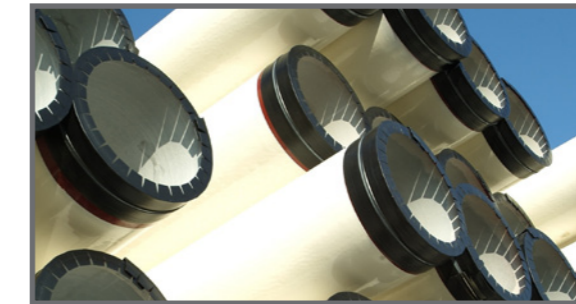

- ZMU cement mortar until DN700 for rocky ground



### Did you know

At the end of its life, PAM pipelines have the significant benefit of being infinitely recyclable through local systems (collection and recovery of scrap metal). This benefit arises from the use of ductile iron, which is produced mainly from recycled materials and is itself 100% recyclable without losing its mechanical properties. This optimised re-use of materials makes the resource inexhaustible.

Furthermore, ductile iron produced from mineral sources is completely inert and non toxic.

### Ductile iron

For decades, PAM ductile iron's reputation for strength, durability and reliability has been recognised worldwide.

**Universal Ve self-anchored joint: "a proven technology giving access to trenchless operations".**

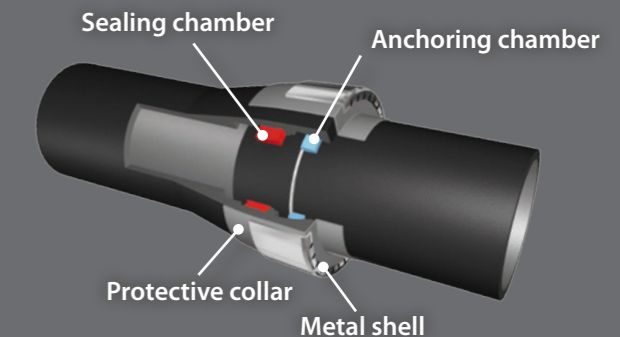



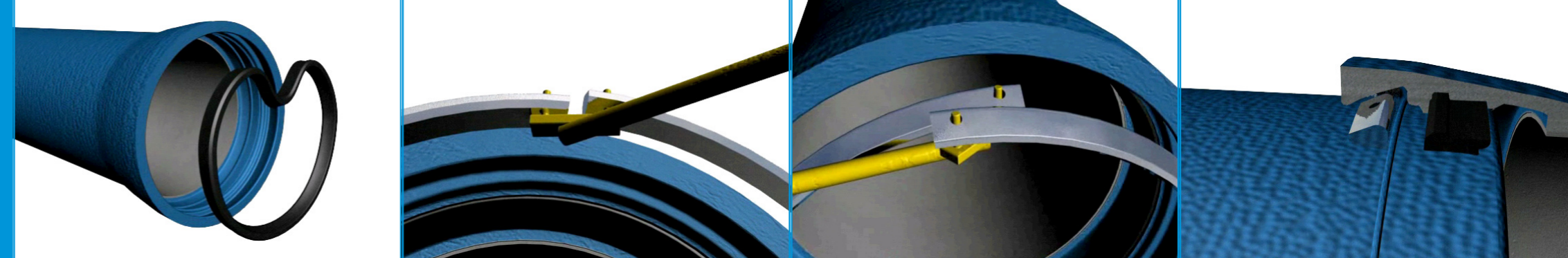

### Angular deflection and curve radius

DN	Joint	Angular deflection	PFA (bar)	Allowable curve radius (m)
100	Uni Ve	3°	64	115
150	Uni Ve	3°	55	115
200	Uni Ve	3°	50	115
250	Uni Ve	3°	45	115
300	Uni Ve	3°	40	115
350	Uni Ve	3°	38	115
400	Uni Ve	3°	35	115
450	Uni Ve	3°	32	115
500	Uni Ve	3°	30	115
600	Uni Ve	2°	27	172
700	Uni Ve	2°	25	172
800	Uni Ve	2°	25	364
900	Uni Ve	1.5°	25	445
1000	Uni Ve	1.2°	25	572

The maximum allowable pulling forces are established based on the maximum pressure supported by the Universal Ve self-anchored joints.

These values are subject to reduction by taking into account the specific dynamic constraints of each individual project (continuous pulling, pulling by pre-assembled section, pulling pipe by pipe).

### Allowable pulling forces (kN)

DN	Pulling lengths (km)					
	0 to 0,4	0,5	0,7	0,9	1	1,2
100	87	84	77	70	66	59
125	114	109	100	91	87	78
150	136	131	120	109	104	93
200	201	193	177	161	153	137
250	271	260	239	217	206	184
300	342	329	301	274	260	233
350	426	409	375	341	324	290
400	506	486	445	405	384	344
450	579	556	510	463	440	394
500	667	640	587	533	507	453
600	855	821	752	684	650	581
700	1000	961	881	801	761	681
800*	1225	1177	1078	981	932	834
900*	1473	1415	1297	1179	1120	1002
1000*	1725	1657	1519	1381	1312	1174

#### (\*) Allowable pulling forces for pipelines DN 800, DN 900 and DN 1000

The values in the table are for information only. Large diameter projects require all elements specific to the project to be taken into account, in particular the profile along its length, geotechnical data and pipe laying constraints. Only recommendations defined by PAM will be binding.

### Did you know

To form a 30° curve, only 10 pipes are required!

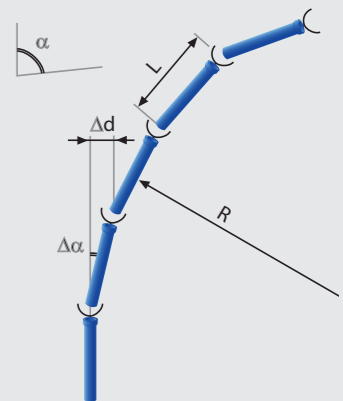

## A high security technology

For trenchless pipe laying, PAM has designed a particularly effective anchoring system which guarantees optimum sealing and flexibility while supporting pulling efforts as high as 100 tonnes for the largest diameters.

**Ductile iron + self-anchored joint + liner + metal shell  
= solidity + flexibility + leak tightness!**



# The material







## Advanced technology

In the pipeline laying field, PAM uses advanced technology that comes directly from oil drilling techniques.



## Drill performance

Depending on the diameter of the pipes to be laid, the length of the path and the nature of the soil, different types of drilling rig must be used.

Types of drilling rig	Pulling force in kN	Maximum torque in kN.m	Mass to be pulled in tonnes	Maximum pipe string length
N°10 : Mini 	≤ 150	10 – 15	< 10	E.g.: 500 linear metres in DN 100
N°11 : Midi 	> from 150 to ≤ 400	15 – 30	10 – 25	E.g.: 500 linear metres in DN 300
N°12 Maxi 	> from 400 to ≤ 2500	30 - 100	25 – 60	E.g.: 500 linear metres in DN 450
N°13 : Méga 	> 2500	> 100	> 60	DN > 500

## Did you know

All PAM joints are protected by a metal shell to guarantee that the elastomer liners will be held in place, particularly in the event of accidental rubbing against the vault during pulling.

## Drill utilisation guide:

**SAFETY, SITE ORGANISATION, FEEDBACK.**

**These themes are all covered in the best practice guide issued by SOFFONS(\*)**

(\*) Syndicat des Entrepreneurs de Sondages, Forages et Fondations Spéciales - the Union of Surveying, Drilling and Special Foundations Contractors.





# The PAM service



The PAM product offering has been progressively enhanced by service solutions. These are offered before projects, with calculation support for designers, as well as later, with pipe laying teams trained by our technicians.

Sales engineering teams and business managers have access to tools and utilities enabling them to examine technical dossiers in detail, accurately calculate allowable pulling forces, the safety coefficients offered as well as the parameters required to ballast the pipe.

Each study is considered to be unique and is carried out with the engineering consultants responsible for project design.

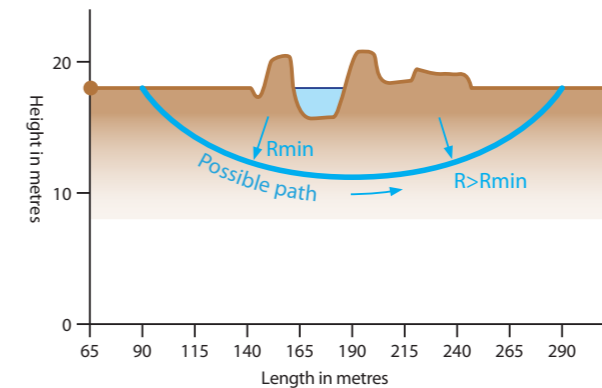

## Did you know

The Moselle river was crossed by a DN 150 pipeline over a length of 210m. The work was carried out by a drilling machine with a capacity of 20 tonnes.

Operations to carry out drilling, boring, deliver and remove the equipment were completed in a little less than 4 days. The operation to pull pre-assembled pipes itself took less than 3 hours. The final 450mm boring took place in a sandy gravel soil.

## From research to implementation

All projects are supported by customised assistance and the initial technical project study guarantees the success of the pulling operation.

**Projects examined by our sales engineering teams are carried out according to the ISO 13470(\*) standard and comply with the French Guide of Practice Fascicule 70 relating to initial geotechnical research.**

(\*) *Trenchless applications of ductile iron pipe systems - Product design and installation*





# The PAM experience



Initially developed in Europe for the German market, combining the trenchless pipe laying technique with PAM products has continued to develop.

Operating in the trenchless field in France for more than 20 years, PAM has been the supplier to more than 250 construction sites in Europe, the largest in terms of diameter being in the Netherlands (DN 800). With lengths varying between 25 and 1500 linear metres (DN 150), this process can meet the requirements of all projects.

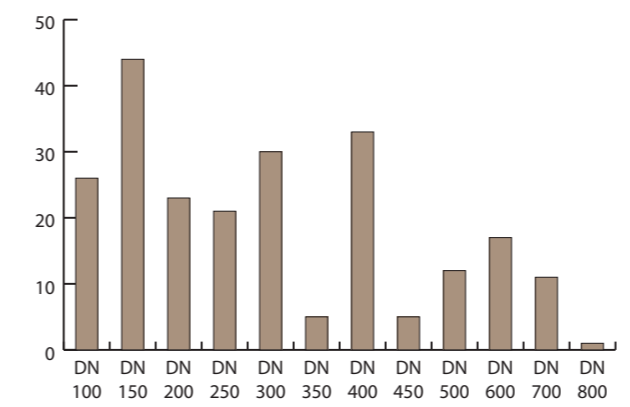

Number of HDD operations by DN

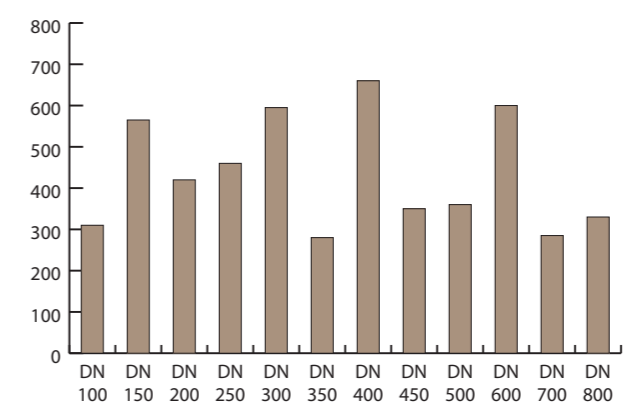

Average length in m by DN

## Did you know

### PAM records

	Lieu	Longueur	DN	Année
<b>The longest</b>	Hamburg Germany	1500 m	150	2003
<b>The largest diameter in Europe</b>	The Netherlands	330 m	800	2004
<b>The largest diameter in France</b>	Lille	240 m	700	2006

## Many references, one expertise

With more than 20 years working in the field of trenchless pipe laying, PAM has gained sufficient experience to operate on the most technically demanding sites.

**More than 90,000 linear metres of PAM pipes have been laid to-date using horizontal directional drilling. The equivalent of 2 Channel tunnels!**



# The PAM range

## DIREXIONAL TT PE and TT PUX pipes (normal situations)

DN mm	L mm	e mm	DE mm	B mm	Mass kg	Exterior coating	Part no.
100	5.95	6.0	118.0	188.0	118	TT PE	227925
125	5.95	6.0	144.0	215.0	147	TT PE	227926
150	6.00	6.0	170.0	230.0	175	TT PE	227928
200	5.96	6.3	222.0	290.0	241	TT PE	227929
250	5.95	6.8	274.0	350.0	320	TT PE	227937
300	5.95	7.2	326.0	408.0	405	TT PE	227938
350	5.97	7.7	378.0	463.0	512	TT PE	227945
400	5.97	8.1	429.0	510.0	602	TT PE	227946
450	5.97	8.6	480.0	570.0	718	TT PE	228956
500	5.97	9.0	532.0	625.0	833	TT PE	227947
600	5.97	9.9	635.0	740.0	1067	TT PE	227948
700	5.97	10.8	736.6	855.0	1399	TT PE	227949
800	6.88	11.7	840.4	980.0	1941	TT PUX	229157
900	6.87	12.6	943.2	1087.0	2367	TT PUX	229158
1000	6.88	13.5	1046.0	1191.0	2814	TT PUX	229160

Sewage and Wastewater: INTEGRAL range - available upon request

## DIREXIONAL TT ZMU pipes (for rocky soils)

DN mm	L mm	e mm	DE mm	B mm	Mass kg	Exterior coating	Part no.
100	5.97	6.0	128.0	196.0	133.5	TT ZMU	224302
125	5.97	6.0	154.0	225.0	166.0	TT ZMU	224303
150	5.97	6.0	180.0	251.0	195.4	TT ZMU	224305
200	5.97	6.3	232.0	307.0	268.1	TT ZMU	224307
250	5.97	6.8	284.0	367.0	353.5	TT ZMU	224308
300	5.97	7.2	336.0	425.0	445.5	TT ZMU	224309
350	5.97	7.7	378.0	480.0	527.0	TT ZMU	224310
400	5.97	8.1	439.0	535.0	650.3	TT ZMU	224311
500	5.97	9.0	542.0	647.0	891.4	TT ZMU	224312
600	5.97	9.9	645.0	750.0	1135.4	TT ZMU	224313
700	5.97	10.8	748.0	865.0	1392.8	TT ZMU	224314

### Nature of coatings

TT PE: extruded HDPE coating

TT PUX: reinforced polyurethane coating

TT ZMU: cement mortar coating

thickness: 2.00 to 2.50mm according to DN

thickness: 1,800µm

thickness: 5,00mm

## Universal Ve self-anchored joints

DN mm	EPDM Standard gasket		Metal locking ring	
	Part no.	Mass (kg)	Part no.	Mass (kg)
100	JSB10BA	0.196	110259	0.500
125	JSB12BA	0.244	124151	0.700
150	JSB15BA	0.285	AKB15E	0.900
200	JSB20BA	0.384	AKB20E	1.300
250	JSB25BA	0.497	AKB25E	1.300
300	JSB30BA	0.712	AKB30E	1.800
350	JSB35BA	0.898	JKB35E	2.300
400	JSB40BA	1.077	JKB40E	3.600
450	JSB45BA	1.323	JKB45E	4.050
500	JSB50BA	1.544	JKB50E	4.600
600	JSB60BA	2.162	JKB60E	8.600
700	JSB70BA	2.871	110671	9.700
800	JSB80BA	3.670	JFB80S	17.300
900	JSB90BA	4.612	JFB90S	22.600
1000	JSC10BA	5.588	JFC10S	24.800

DN 100 to 200    DN 250 to 350    DN 400 to 700    DN 800 to 1200

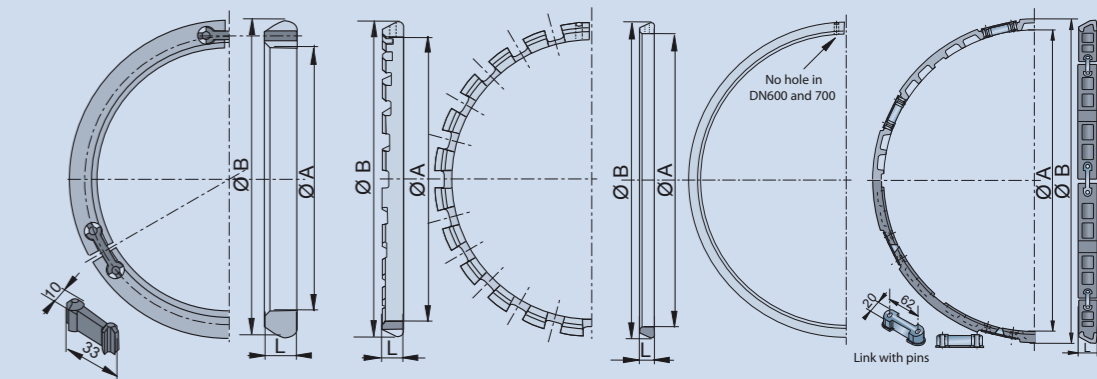

## Universal Ve metal retaining rings

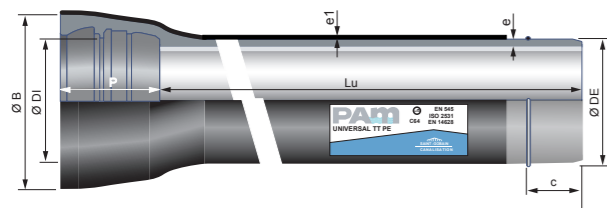

TT PE – DN 100 to DN 700

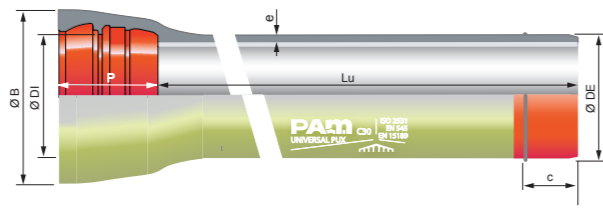

TT PUX – DN 800 to DN 1000

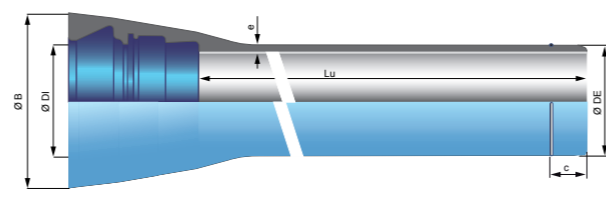

TT ZMU – DN 100 to DN 700

Assembly/dismantling accessories and tools  
Please contact our sales and sales engineering teams



# The PAM range

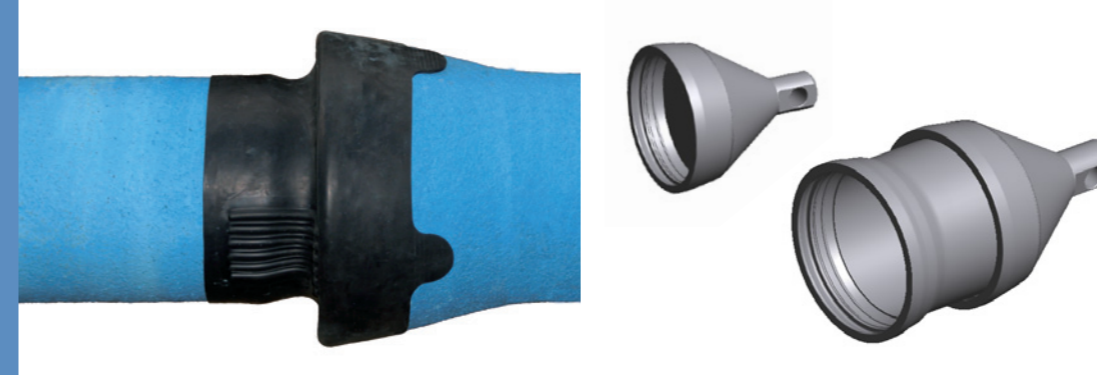

## HDD metal protection cone

DN mm	Part no.	Mass kg	Width mm	Thickness mm
100	110326	0.70	120	1.00
125	209752	0.75	120	1.00
150	110325	0.85	120	1.00
200	110324	1.20	130	1.00
250	110323	1.50	140	1.00
300	110322	1.80	155	1.00
350	207176	2.80	160	1.20
400	110321	3.00	170	1.20
450	211369	3.20	170	1.20
500	110320	3.50	180	1.20
600	110327	5.00	195	1.20
700	110328	6.00	210	1.20
800	228265	8.00	192	1.50
900	228268	11.70	285	1.50
1000	228270	9.00	192	1.50

## TT PE & TT PUX elastomeric muff

DN mm	Exterior coating	Part no.	Type
100	PE	JSB10YAT	TT PE muff
125	PE	JSB12YAT	TT PE muff
150	PE	JSB15YAT	TT PE muff
200	PE	JSB20YAT	TT PE muff
250	PE	JSB25YAT	TT PE muff
300	PE	JSB30YAT	TT PE muff
350	PE	158071	Tubular sleeve
400	PE	158080	Tubular sleeve
450	PE	158094	Tubular sleeve
500	PE	158094	Tubular sleeve
600	PE	123649	Tubular sleeve
700	PE	211186	Tubular sleeve
800	PUX	30 m roll réf. 158030	Band & roll
900	PUX	+ band (x50) réf. 158098	Band & roll
1000	PUX		Band & roll

## TT ZMU elastomeric muff

DN mm	Exterior coating	Part no.	Type
100	TT ZMU	110823	ZMU muff
125	TT ZMU	173263	ZMU muff
150	TT ZMU	110821	ZMU muff
200	TT ZMU	110822	ZMU muff
250	TT ZMU	110828	ZMU muff
300	TT ZMU	110834	ZMU muff
350	TT ZMU	110789	ZMU muff
400	TT ZMU	110750	ZMU muff
500	TT ZMU	110773	ZMU muff
600	TT ZMU	110776	ZMU muff
700	TT ZMU	110026	ZMU muff

## Pulling head for horizontal directional drilling

DN mm	Part no.	Part no.	Type	Mass kg
100	173371 - E01	Universal Tis-K	One piece	21.00
125	177688 - E01	Universal Tis-K	One piece	21.00
150	177686 - E01	Universal Tis-K	One piece	31.00
200	177685 - E01	Universal Tis-K	One piece	42.00
250	177684 - E01	Universal Tis-K	One piece	70.00
300	177683 - E01	Universal Tis-K	2 pieces	200.00
350	177689 - E01	Universal Ve	2 pieces	260.00
400	215720 - E01	Universal Ve	2 pieces	290.00
450	184694 - E01	Universal Ve	2 pieces	370.00
500	215792 - E01	Universal Ve	2 pieces	445.00
600	215897 - E01	Universal Ve	2 pieces	604.00
700	215988 - E01	Universal Ve	2 pieces	1050.00
800	229305	Universal Ve	2 pieces	1450.00
900	229307	Universal Ve	2 pieces	1920.00
1000	229309	Universal Ve	2 pieces	2110.00



elastomeric muff

heat-shrink sleeve

Accessories and assembly/dismantling tools  
Please contact our sales and sales engineering teams



# SAINT-GOBAIN PAM worldwide

## ALGERIA

**SAINT-GOBAIN PAM ALGERIE**  
Z.I. Sidi Abdelkader-Ben Boulaïd - BP 538  
09000 - BLIDA - Algeria  
Phone: + 213 (0) 25 36 00 60

## ARGENTINA

**SAINT-GOBAIN PAM ARGENTINA**  
Bouchard y Enz  
1836 - LLAVALLOL - BUENOS AIRES - Argentina  
Phone: + 54 11 42 98 9600

## AUSTRALIA

**SAINT-GOBAIN PAM**  
15 Edgars Road  
THOMASTOWN VIC 3074 - Australia  
Phone: + 61 (0) 3 9358 6122

## AUSTRIA

**SAINT-GOBAIN GUSSROHRVERTRIEB  
ÖSTERREICH GmbH**  
Archenweg, 52  
A-6020 - INNSBRUCK - Austria  
Phone: + 43 512 341 717-0

## BELGIUM

**SAINT-GOBAIN PIPE SYSTEMS**  
Raatshovenstraat, n°2  
B-3400 - LANDEN - Belgium  
Phone: + 32 11 88 01 20

## BRAZIL

**SAINT-GOBAIN CANALIZACAO LTDA**  
Praia de Botafogo 440 7º andar  
22250-040 - RIO DE JANEIRO - RJ - Brazil  
Phone: + 55 21 2128 1677

## CHILE

**SAINT-GOBAIN PAM CHILE**  
Antillanca Norte 600  
Parque Industrial Vespucio, Comuna de Pudahuel  
SANTIAGO DE CHILE - Chile  
Phone: + 562 444 13 00

## CHINA

**SAINT-GOBAIN PAM CHINA (SHANGAI)**  
1812 Ocean Tower  
550 Yan'An East Road - SHANGAI 200001 - China  
Phone: + 86 21 6361 2165

## SAINT-GOBAIN PAM CHINA (XUZHOU)

Dong Jiao Yangzhuang  
PC 221004 - XUZHOU - Jiangsu Province - China  
Phone: + 86 516 8787 8107

## SAINT-GOBAIN PAM CHINA (MAANSHAN)

Hua Gong Road Cihu  
PC 243052 - MAANSHAN Anhui Province - China  
Phone: + 86 555 350 8040

## COLOMBIA

**SAINT-GOBAIN PAM COLOMBIA**  
Terminal terrestre de carga de Bogota  
Etapa 1, Bodega 9, Modulo 3  
Km 3,5 costado sur autopista - Medellin  
COTA CUNDINAMARCA - Colombia  
Phone: + 57 (1) 841 5832

## CZECH REPUBLIC

**SAINT-GOBAIN PAM CZ s.r.o.**  
Počernická 272/96  
108 03 Praha 10 - Czech Republic  
Phone: + 296 411 746

## FINLAND

**SAINT-GOBAIN PIPE SYSTEMS OY**  
Nuijamiestentie 3A  
FIN-00400 - HELSINKI - Finland  
Phone: + 358 207 424 600

## FRANCE & DOM-TOM

**SAINT-GOBAIN PAM (HEAD OFFICE)**  
91 Avenue de la Libération  
54076 NANCY CEDEX - France  
Phone: +33 3 83 95 20 00

## SAINT-GOBAIN PAM

(France Commercial Department)  
CRD - Chemin de Blénod - B.P. 109  
54704 PONT A MOUSSON CEDEX - France  
Phone: +33 3 83 80 73 00

## SAINT-GOBAIN PAM

(Europe and International Commercial Departments)  
21 avenue Camille Cavallier  
54705 - PONT A MOUSSON CEDEX - France  
Phone: + 33 3 83 80 67 89

## SAINT-GOBAIN PAM

(Local Agency of The Antilles)  
Rue Alfred Lumière - ZI de Jarry - BP 2104  
97122 - BAIE MAHAULT - Guadeloupe  
Phone: + 33 590 26 71 46

## SAINT-GOBAIN PAM

(Local Agency of Indian Ocean)  
16, Rue Claude Chappe - ZAC 2000  
97420 - LE PORT - Reunion Island  
Phone: + 33 262 55 15 34

## GERMANY

**SAINT-GOBAIN PAM DEUTSCHLAND**  
Saarbrucker Strasse 51  
66130 - SAARBRUCKEN - Germany  
Phone: + 49 681 87 010

## GREECE

**SAINT-GOBAIN SOLINOURGEIA**  
5 Klissouras Str.  
GR 14482 - METAMORFOSI - ATHENS - Greece  
Phone: + 30 210 28 31 804

## HONG KONG

**SAINT-GOBAIN PIPELINES**  
H15/F Hermes Commercial Centre - 4-4A Hillwood Road  
TSIM SHA TSUI - KOWLOON - Hong Kong  
Phone: + 852 27 35 78 26

## INDIA

**SAINT-GOBAIN PAM**  
Grindwell Norton Ltd  
5th Level, Leela Business Park - Andheri-Kurla Road  
MUMBAI - 400059 - India  
Phone: + 91 22 402 12 121

## ITALY

**SAINT-GOBAIN PAM ITALIA SPA**  
Via Romagnoli n°6  
I-20146 - MILAN - Italy  
Phone: + 39 02 42 431

## JORDAN

**SAINT-GOBAIN PAM REGIONAL OFFICE**  
Abu Zaid Center - Office # 8  
35 Saad Bin Abi Waqqas St. - PO BOX 831000  
11183 AMMAN - Jordan  
Phone: + 962 6 551 4438

## MOROCCO

**SAINT-GOBAIN PAM REGIONAL OFFICE**  
2 allée des Figuier - Ain Sebaâ  
CASABLANCA - Morocco  
Phone: + 212 522 66 57 31

## MEXICO

**SAINT-GOBAIN PAM MEXICO**  
HORACIO 1855-502 - Colonia Los Morales - Polanco  
11510 - MEXICO D.F. - Mexico  
Phone: + 52 55 5279 1657

## NETHERLANDS

**SAINT-GOBAIN PIPE SYSTEMS**  
Markerkant 10-17  
1316 - AB ALMERE - Nederland  
Phone: + 31 36 53 333 44

## NORWAY

**SAINT-GOBAIN BYGGEVERER AS**  
Division PAM Norge  
Brobekkeveien 84  
0582 - OSLO - Norway  
Phone: + 47 23 17 58 60

## PERU

**SAINT-GOBAIN PAM PERU**  
Avenida de los Faisanes N° 157 - Chorillos  
LIMA 09 - Peru  
Phone: + 511 252 40 34/35

## POLAND

**SAINT-GOBAIN CONSTRUCTION PRODUCTS POLSKA  
SP Z.O.O - PAM Business Unit**  
Ul. Cybernetyki 21  
PL-02-677 WARSZAWA - Poland  
Phone: + 48 22 751 41 72

## PORTUGAL

**SAINT-GOBAIN PAM PORTUGAL**  
Est. Nac. 10 - Lugar de D. Pedro - Apartado 1708  
P-2691-901 - SANTA IRIA DE AZOIA - Portugal  
Phone: + 351 218 925 000

## ROMANIA

**SAINT-GOBAIN CONSTRUCTION PRODUCTS  
ROMANIA S.R.L. - PAM Business Unit**  
Strada Tipografilor nr. 11-15, Corp 84,  
Etaj 3, Birourile 323-338, Sector 1,  
BUCHAREST - Romania  
Phone: + 40 21 207 57 37

## SLOVAKIA

**SAINT-GOBAIN CONSTRUCTION PRODUCTS  
PAM Business Unit**  
Stara Vajnorska 139  
83104 - BRATISLAVA - Slovakia  
Phone: + 421 265 45 69 61

## SOUTH AFRICA

**SAINT-GOBAIN CONSTRUCTION PRODUCTS  
PAM Business Unit**  
N1 Business Park  
Corner Olievenhoutbosch Road & Old Johannesburg Road  
Samrand - PO BOX 700  
GERMISTON - South Africa 1400  
Phone: +27 12 657 2800

## SPAIN

**SAINT-GOBAIN PAM ESPANA SA**  
Paseo de la Castellana n°77 - Edificio Edera - Planta 10  
E-28046 - MADRID - Spain  
Phone: + 34 91 397 20 00

## UNITED ARAB EMIRATES

**SAINT-GOBAIN PAM**  
PO BOX 47102 - Building N° 1092 - Villa N° 7  
Muroor Road - ABU DHABI - United Arab Emirates  
Phone: + 971 2 448 20 10

## UNITED KINGDOM

**SAINT-GOBAIN PAM UK**  
Lows Lane - Stanton-by-Dale  
ILLKESTON - DERBYSHIRE - DE7 4QU  
United Kingdom  
Phone: + 44 115 930 5000

## VIETNAM

**SAINT-GOBAIN PAM**  
201-203 Cach Mang Thang 8, Ward 4 - District 3  
HO CHI MINH CITY - Vietnam  
Phone: +84 8 39 30 72 74

[www.pamline.com](http://www.pamline.com)

## SAINT-GOBAIN PAM

### Head office

91, avenue de la Libération  
54076 NANCY CEDEX  
FRANCE

## Marketing Department –

### Water & Sewage

21, avenue Camille Cavallier  
54705 PONT-A-MOUSSON CEDEX  
FRANCE  
Phone: +33 (0)3 83 80 67 89